

NATIONAL WORKSHOP on  
“FIRE RESEARCH IN PROPULSION SYSTEMS”

# Pan burn behaviour with different fuels & an approach to modelling

Shiva Kumar. A and Bhaskar Dixit. C.S

Collaborators: Sowriraajan. A. Ve and Mukunda. H. S



Fire & Combustion research Centre  
Jain University, Jakkasandra, Bangalore-562112

# Outline

Introduction

Earlier work

Pans used and experimental design

The experiments

Comparison with results of Chen and Kang (validation check)

Fuel depth effects – with different materials

Is wall conduction responsible for higher burn rates?

What is happening in the liquid phase?

Wall temperature behaviour?

Other fuels – kerosene, diesel and alcohol

Comparison of burn rates

Key points from experiments

The non-dimensional number – basis

The correlation and the results for all the fuels

Conclusions

# Introduction

Pool fire has been a subject of study for six decades from the time Hottel published a review of the Russian work. Considerable information and understanding has been gained over this period with research, fire safety technology and evolution of standards for acceptance of fire safety products have also made progress.

One of the key aspects of importance is the prediction of burn rates from liquid pool fires, particularly because pool fires are a part of the standards for fire extinguishment. While unsteady burn process is the focus of these tests, *most investigators have used steady arrangement to study the burn rate of liquid pool fires, both experimentally and for model development.*

In view of this, in the present study, unsteady pool fire experiments has been conducted on n-heptane, methanol, kerosene and diesel by allowing the fuel thickness ( $h_{fu}$ ) to vary with time for  $h_{fu}$  of 10 mm in 200 mm dia pans.

Data on mass loss, wall temperatures and fuel temperatures at several locations have been obtained for 200 mm diameter pans of 40 mm depth with different materials - *Glass (GL), Stainless steel (SS), Mild steel (MS) and Aluminum alloy (AL)* with a wide range of thermal conductivities.

Many intriguing aspects of the burn behavior have been explored through analysis of data with the aim to develop unsteady modeling using scaling laws.

# Earlier work

A number of researchers have studied pan fires. A large number of them have studied steady pool fires (e.g. Mitchell, John de Ris, Blanchat and others).

Umbrauskas (1983) summarized the burn rate data from several sources for a number of fuels. He has pointed out that transient effects due to lip height (or free board), the nature of bounding material, fuel layer thickness and wind would need to be accounted. There was no specific data or correlations to allow estimation of the effects.

Ummins et al (1994) used a steady configuration of ring burners to enable obtain various pool diameters (75 to 300 mm) and have used several fuels including n-heptane and toluene to measure the burn rates and radiational characteristics as a function of radius and azimuth and their principal conclusion is that the flux is fairly uniform for hydrocarbon fires.

Small pool fires have been studied by Hayasaka (1997) and Chen et al (2011) particularly in the unsteady mode - with fixed fuel thickness and mode in which the fuel burns with time was identified as initial phase, steady phase, transition phase, peak and decay phase. Even Chen et al have done the experiments in 200 mm SS pan at different initial temperatures and found that it affects the burn rate significantly.

The present study goes beyond the earlier studies in obtaining experimental data on unsteady pool fires with different geometric parameters and a range of fuels attempting to extract various effects systematically.

# Pans used for experiments

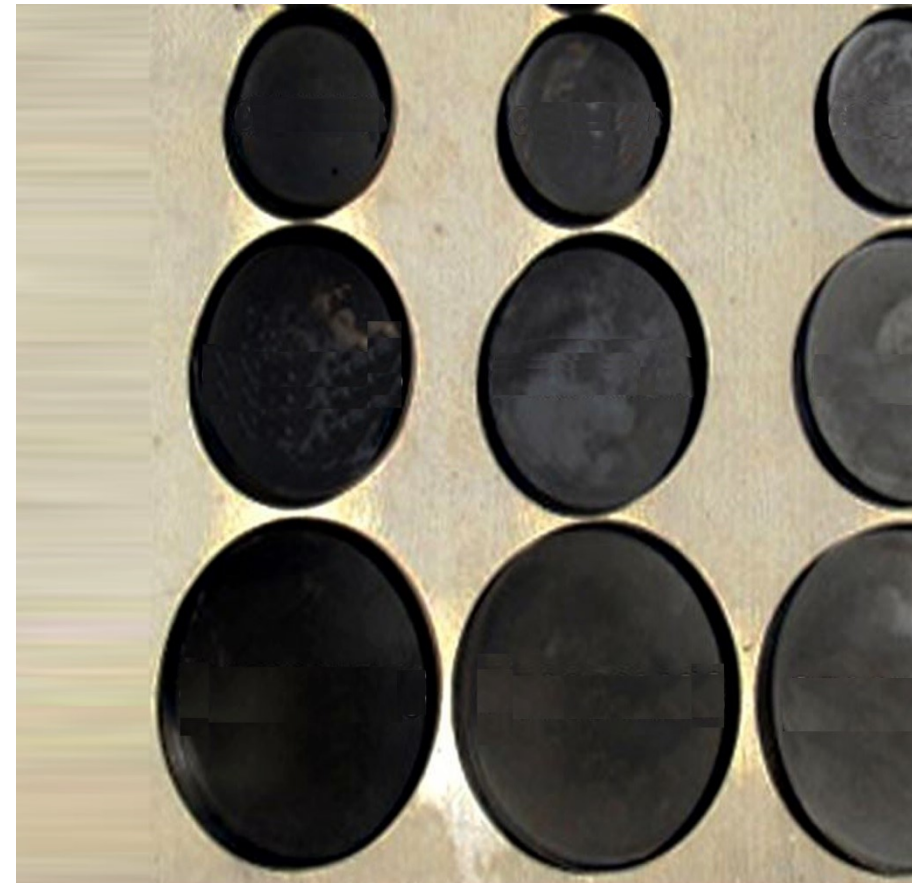
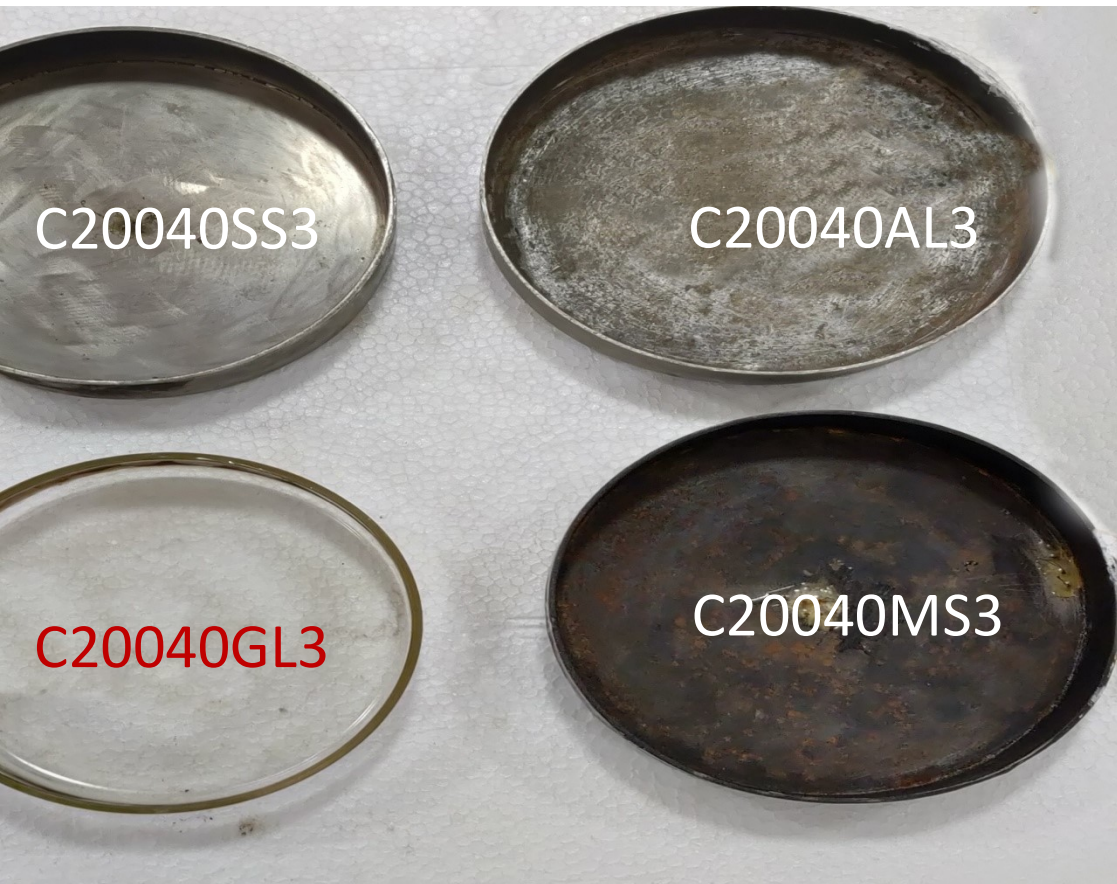

Pans of 200 mm dia, 40 mm depth made of Stainless Steel (SS), Mild steel (MS), Aluminum alloy (Al) and glass (GL) (clockwise from the top) on left side and pans of 300, 400 and 500 mm diameter, 40, 50 and 60 mm depth made of MS on the right side

# The burn process and measurements in Pool fires

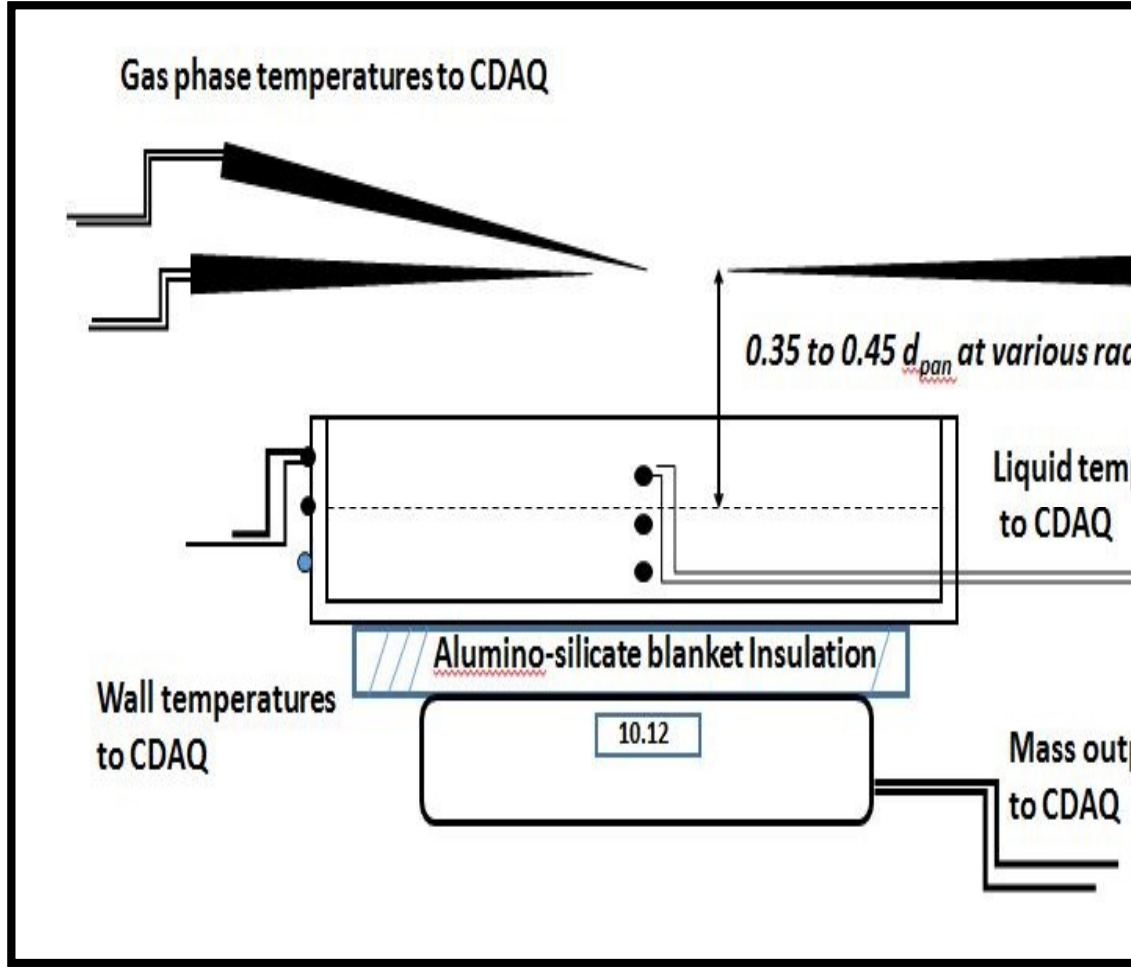
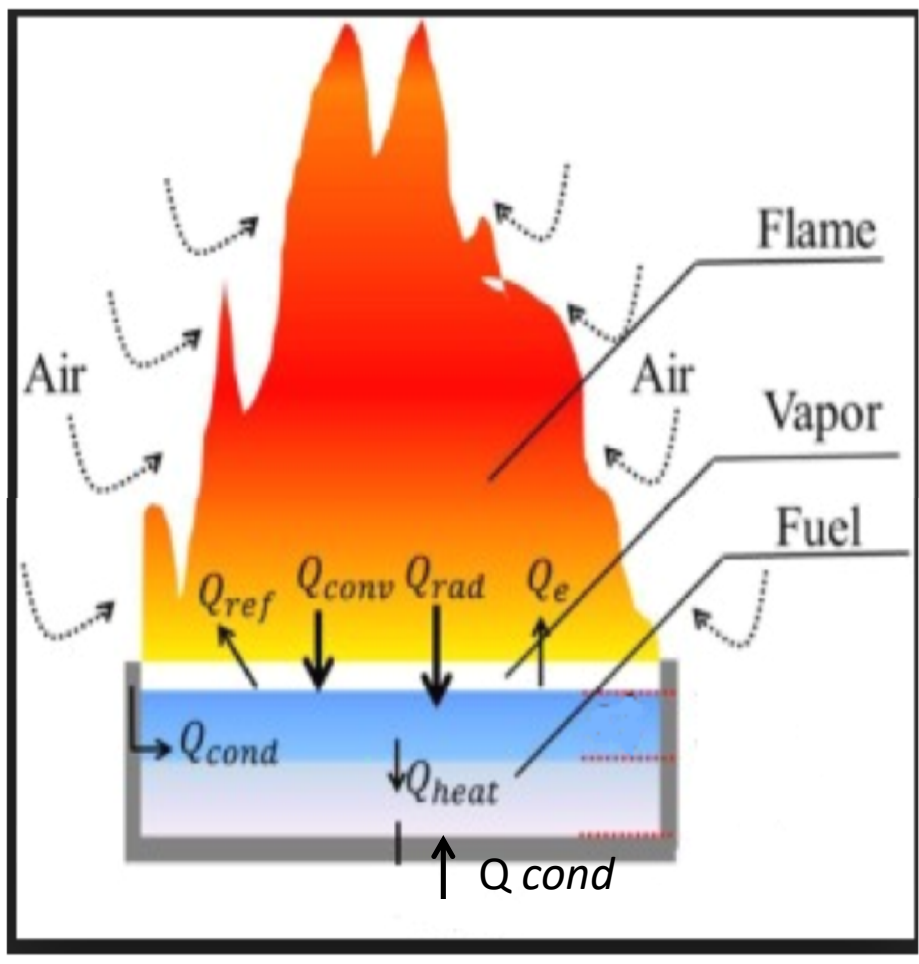

$$\dot{r} = \frac{(\ddot{Q}_{cond} + \ddot{Q}_{conv} + \ddot{Q}_{Rad})}{(L + Cp(T_s - T_0))}$$

Flame picks up in a few seconds, Convective and Radiative fluxes also become effective at this time. Conduction along the walls takes time



# The experiments....

the experiments were conducted at FCRC fire lab are on n-Heptane, kerosene, diesel and alcohols.

Measurements have included fuel mass, centre line in-depth liquid temperature, wall temperatures at heights on the pan wall, bottom wall temperatures, some in which temperatures across the wall, gas temperatures vs burn time in several experiments.

Fuel depths tried were 10 mm, 13mm and 20 mm. The choice of 13 mm was because of earlier studies by Chen et al and Kang et al (from China) for 200 mm SS pan. They have been the only studies of significance attempting to elucidate the unsteady burning behavior in pans.

More than 180 different experiments have been conducted – with four different pans and different fuel depths and repeats to check on accuracies.

Significantly new results have emerged.....

# Comparison of Chen, Kang et al (SS,200 mm pan) data

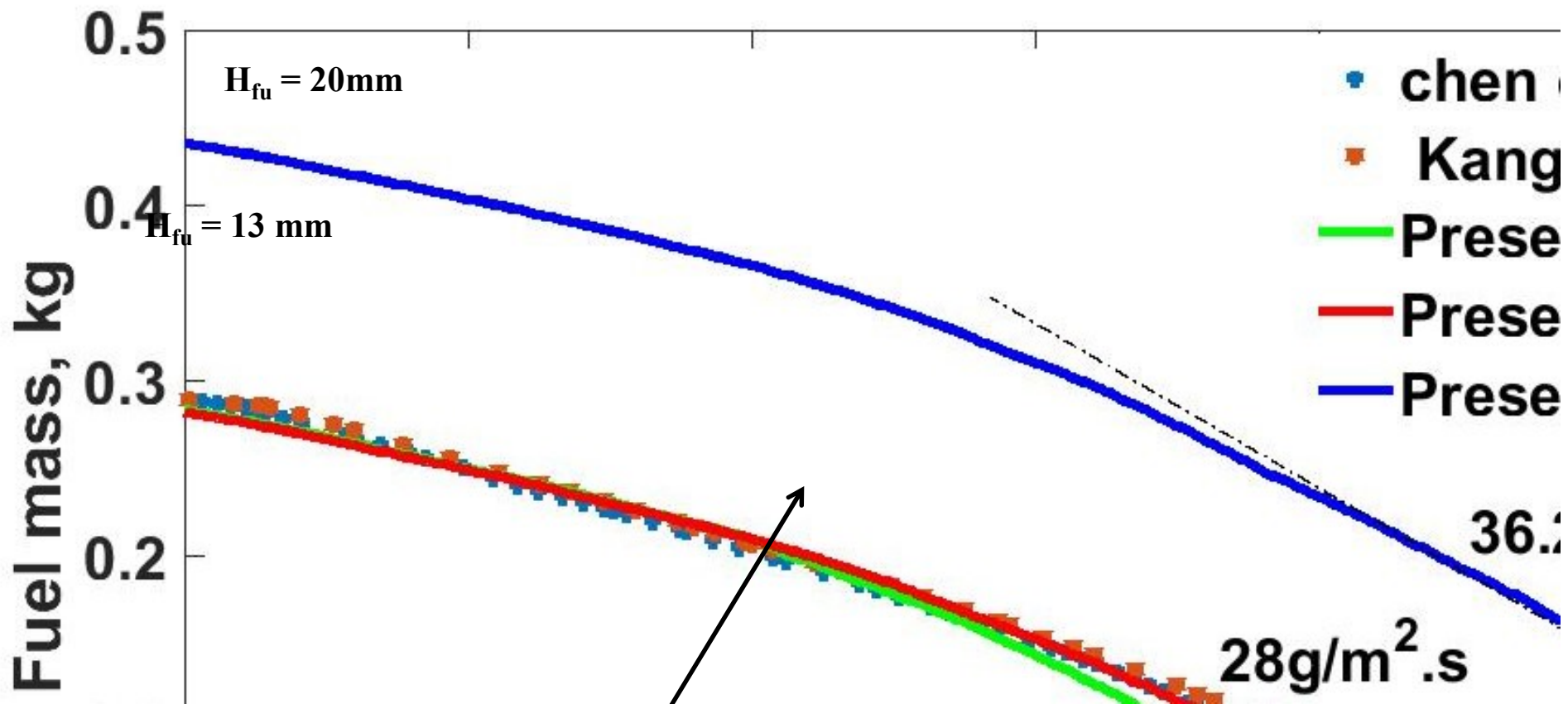

The comparison is considered "good". The higher slopes are due to enhanced initial temperature at FCRC.



# Fuel depth Effect (MS, 200 mm pan) on the mean and Peak Flux for n-hepta

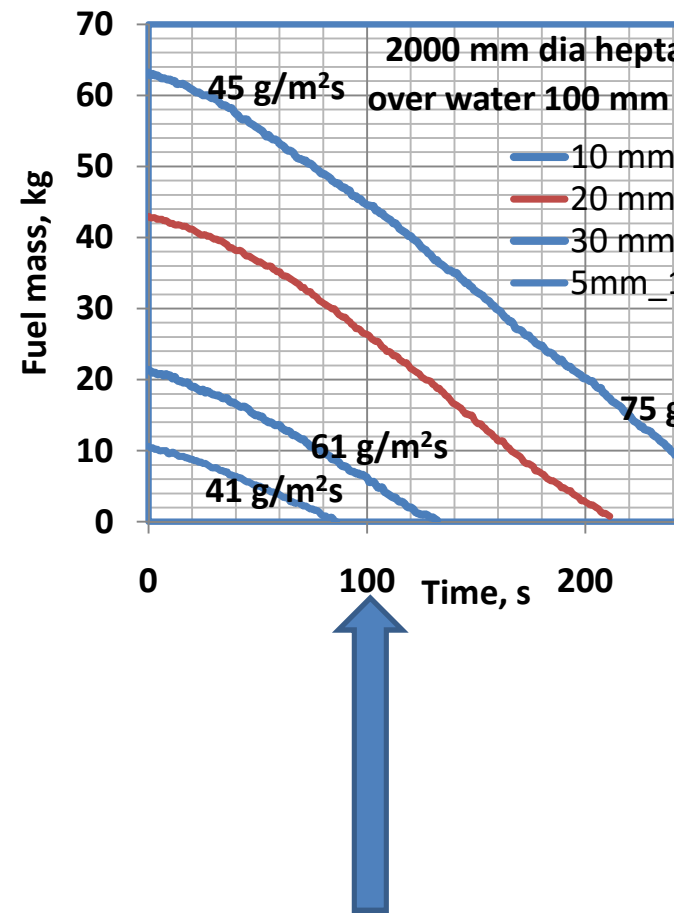
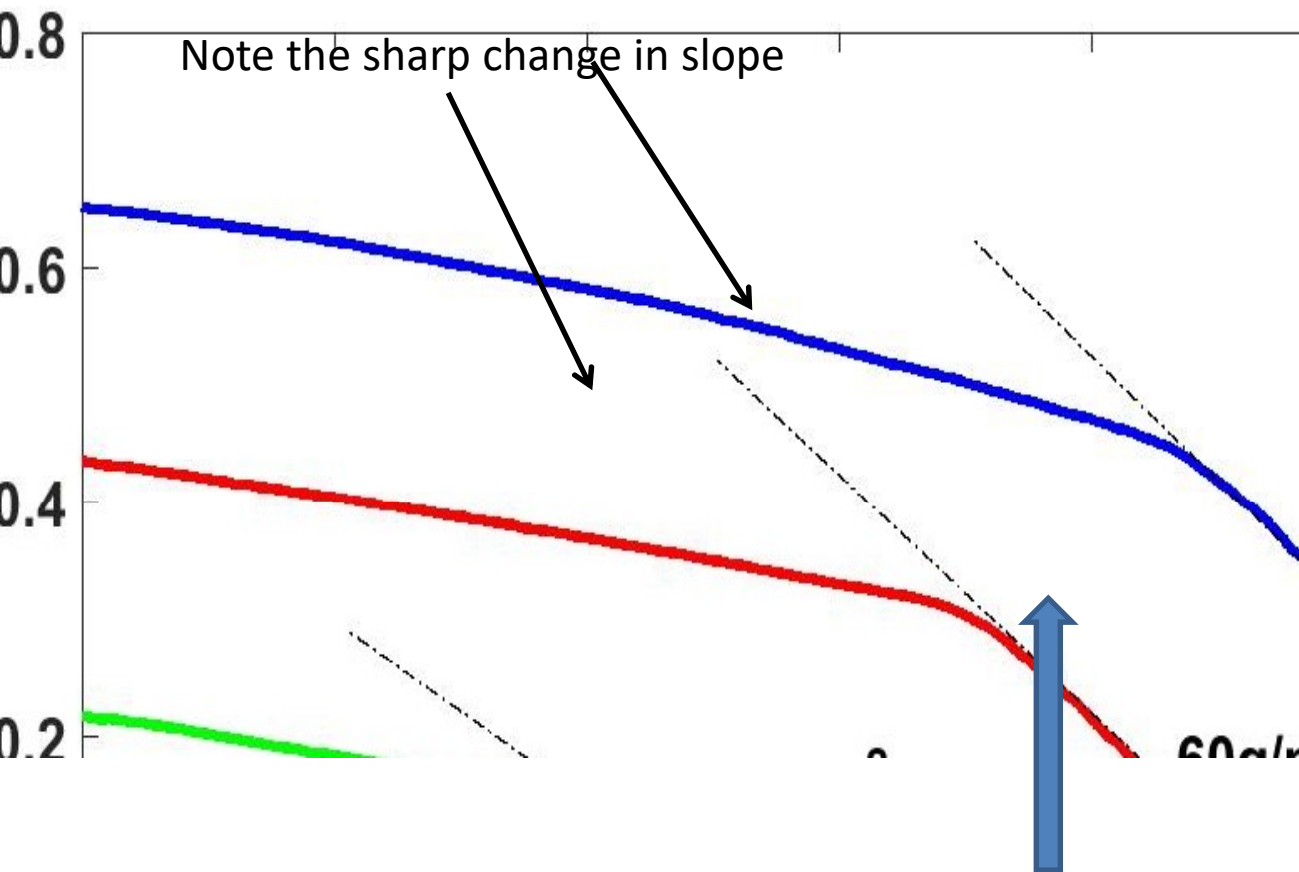

At this small pan diameter, the peak flux is  $67 \text{ g/m}^2 \cdot \text{s}$  at fuel depth  $> 20 \text{ mm}$ , a flux found only in large pans because of significant radiation flux.

A quick inference is that this behavior is related to the liquid in the pool having reached boiling, a feature that needs further investigation.

At this stage, it is thought useful to examine the burn behavior with pans of different materials.

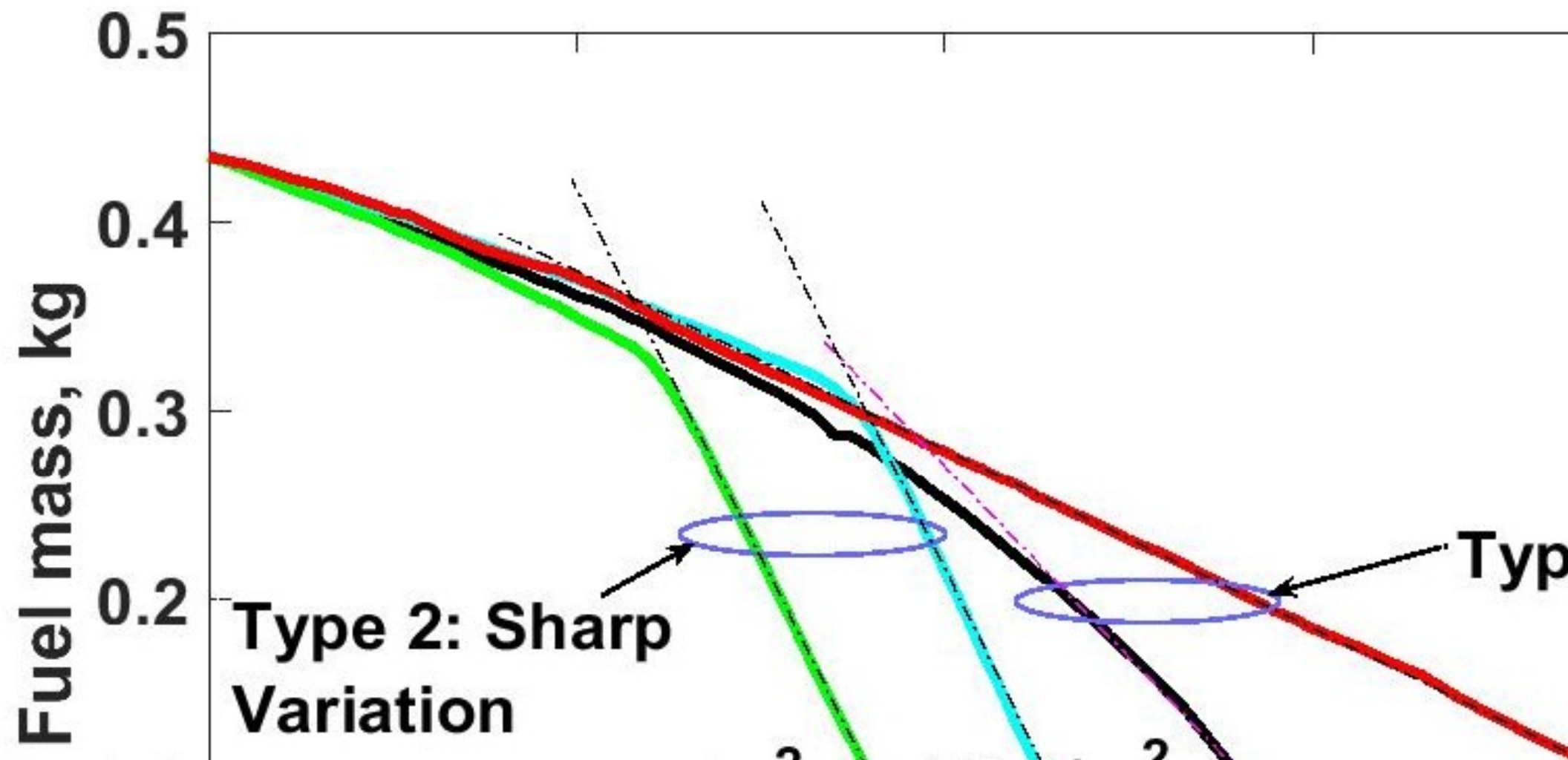

aluminium with thermal conductivity of  $60 \text{ W/m K}$  shows faster burn rate compared to Glass with thermal conductivity of  $1.14 \text{ W/m K}$ .

thermal conductivity of the wall material (and thermal diffusivity) would be the key parameter that results in increased conduction heat transfer in case of AL & MS which results in quick bulk boiling of fuel compared to SS & GL pans.

.NO	Pan Material	Heptane thickness (mm)	Initial Flux g/m <sup>2</sup> .s	Time (sec)	Peak Flux g/m <sup>2</sup> .s	Time (sec)
1	AL	10	11.6	0 to 70	52	110 to 200
2	AL	13	11.6	0 to 60	50	160 to 300
3	AL	20	11.1	0 to 130	60	240 to 410
4	MS	10	10.0	0 to 70	42.8	190 to 310
5	MS	13	11.3	0 to 60	48.2	270 to 400
6	MS	20	10.1	0 to 120	60	350 to 510
7	SS	10	10.4	0 to 70	24.8	240 to 400
8	SS	13	10.1	0 to 60	28.4	320 to 470
9	SS	20	11.1	0 to 120	36.2	460 to 650
10	GL	10	10.0	0 to 280	13.5	415 to 660
11	GL	13	9.1	0 to 180	14.6	520 to 840
12	GL	20	10.6	0 to 120	16.5	340 to 960

Initial flux which is largely controlled by the convection is nearly the same (since radiation is less for smaller diameter pans at initial stage), irrespective of fuel thickness and pan material.

Peak flux varies with the fuel thickness & pan material

Since it was not yet clear whether the conduction or radiation is responsible for peak flux, experiments were conducted to examine the role of wall conduction by suppressing it.....

## Experiment *without* and *with* jacket for water circulation

C200mm dia, 60mm deep MS pan, heptane pool

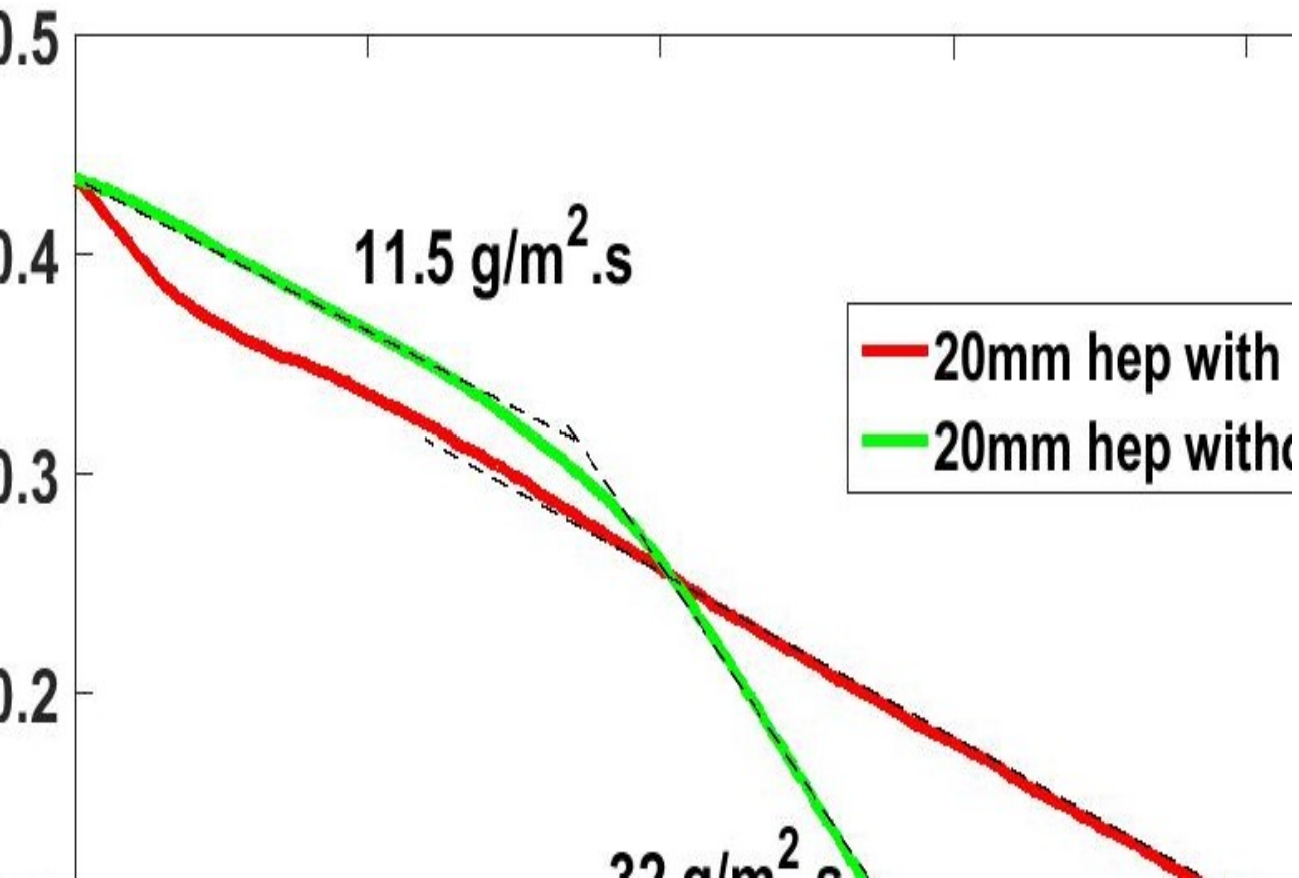

Depth = 60mm



Dia = 200mm

Jacket for water circulation

If the conduction effects are suppressed the burn rate remains unchanged even during peak condition and so *conductive flux is the crucial feature for pans of this diameter*

What is happening in the liquid phase  
with different pan materials?

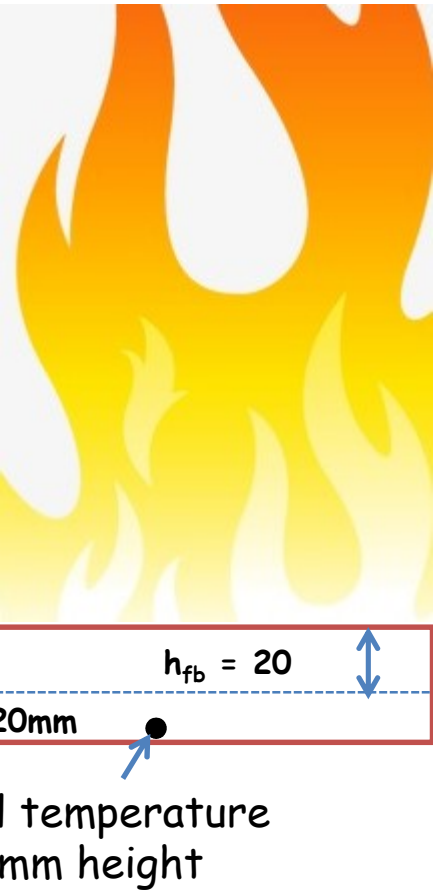

Centreline fuel temperature at 1mm height

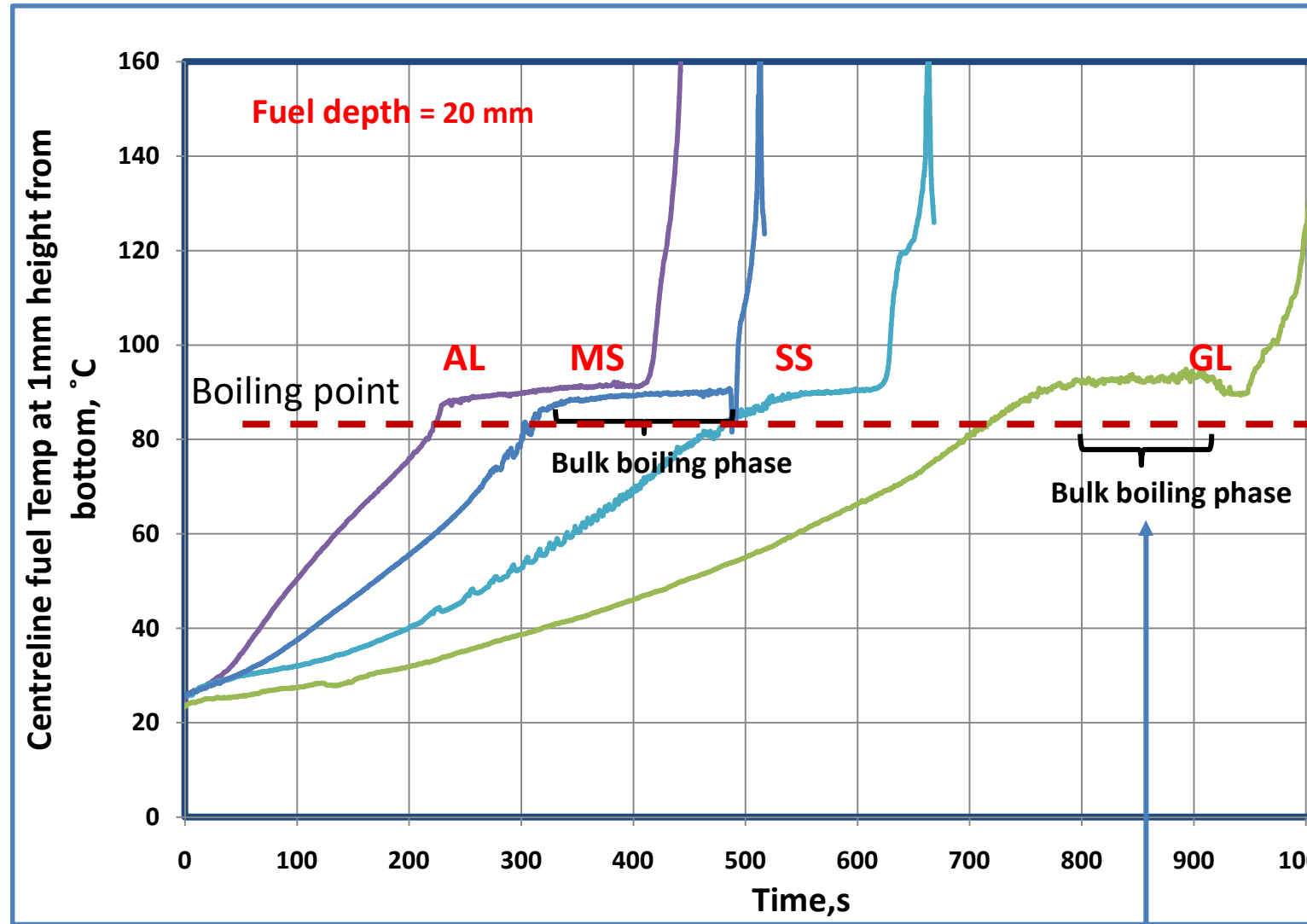

Fuel reaches boiling in materials of higher conductivity earlier – related directly to increased wall conduction heat transfer into the liquid fuel.

The burn rate in the subsequent period is due to bulk boiling



Wall temperature behaviour?

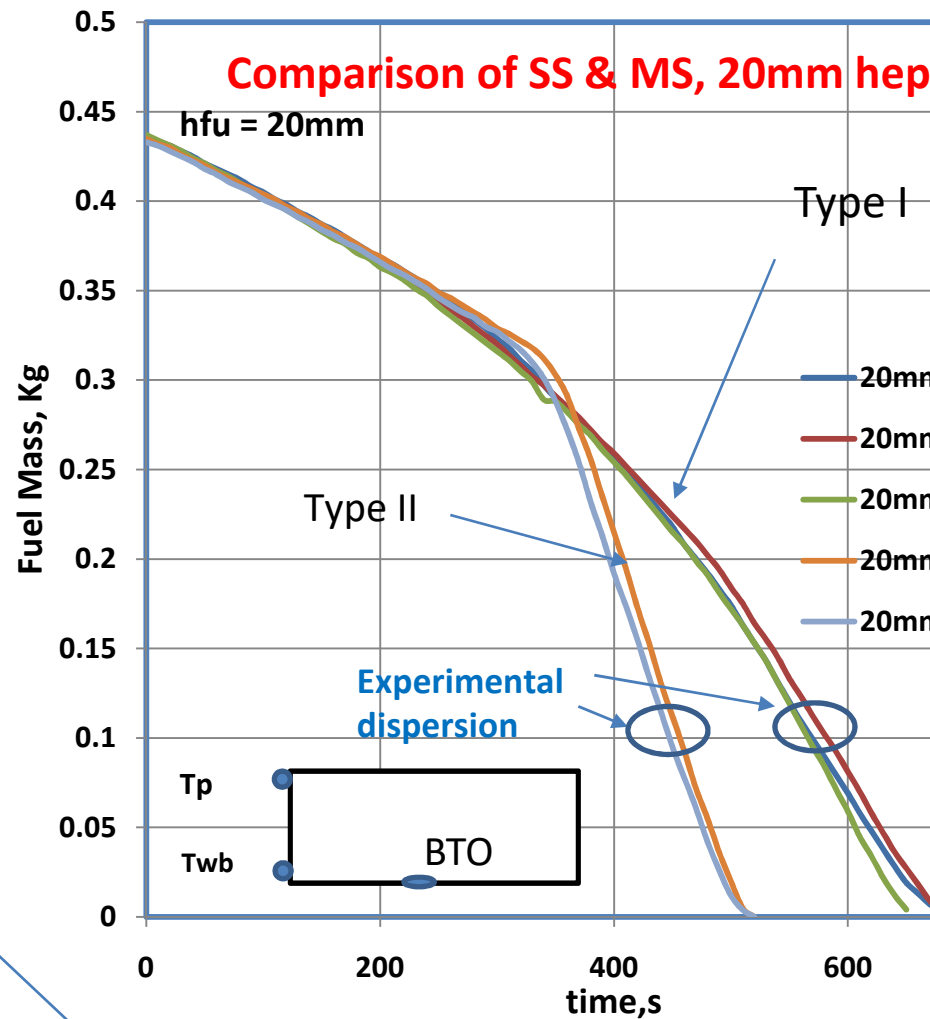
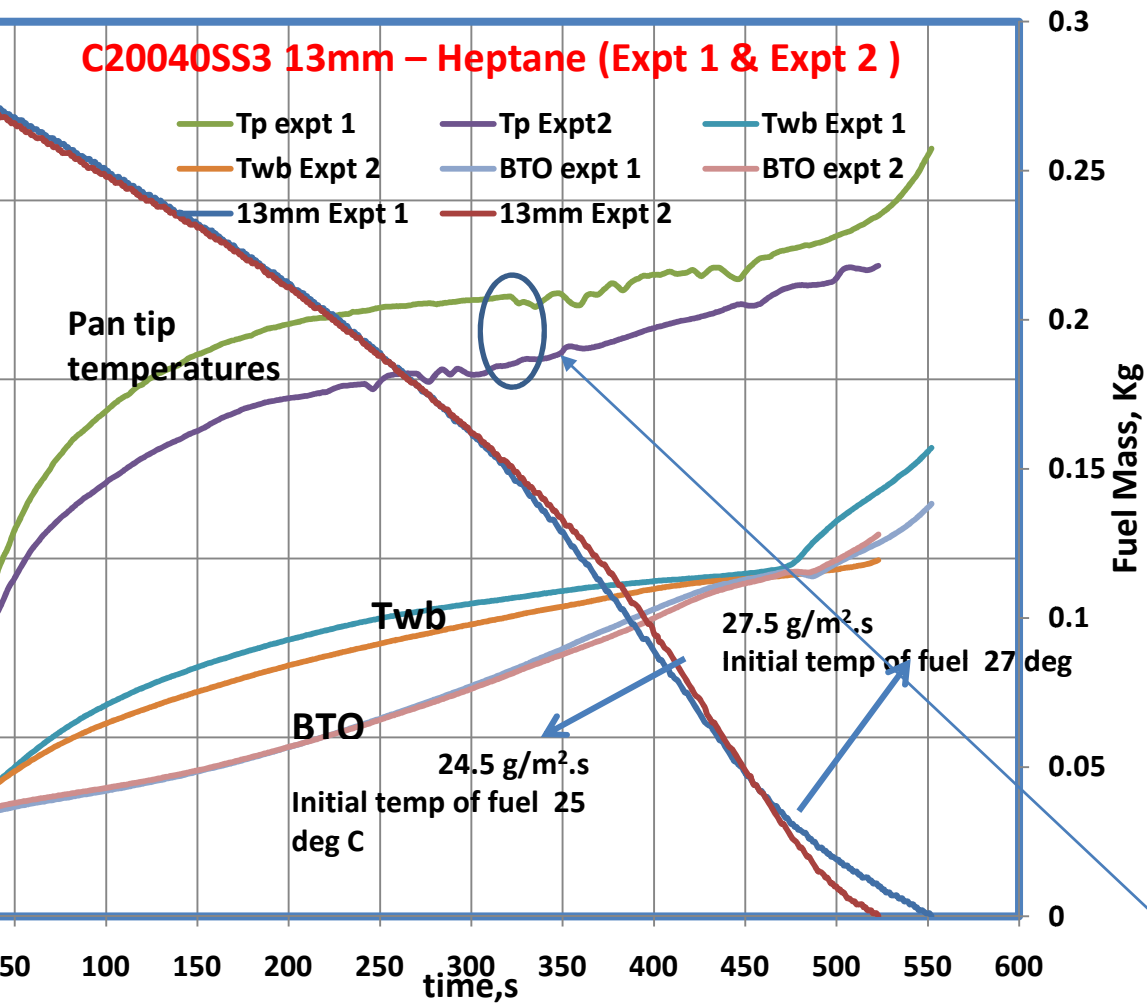

Even though the pan tip temperature difference is about 15 to 20 °C, the burn time variation of two experiments is not much and their behaviour is about the same (all dispersions are within 5 %)

The initial flux for both SS & MS pans are about the same and the peak flux of same pan experiments does not

Other fuels – Kerosene, Diesel and Alcohol

## Fuel depth and material effect on burn rate of kerosene 200 mm dia, 40 mm depth MS and SS pan

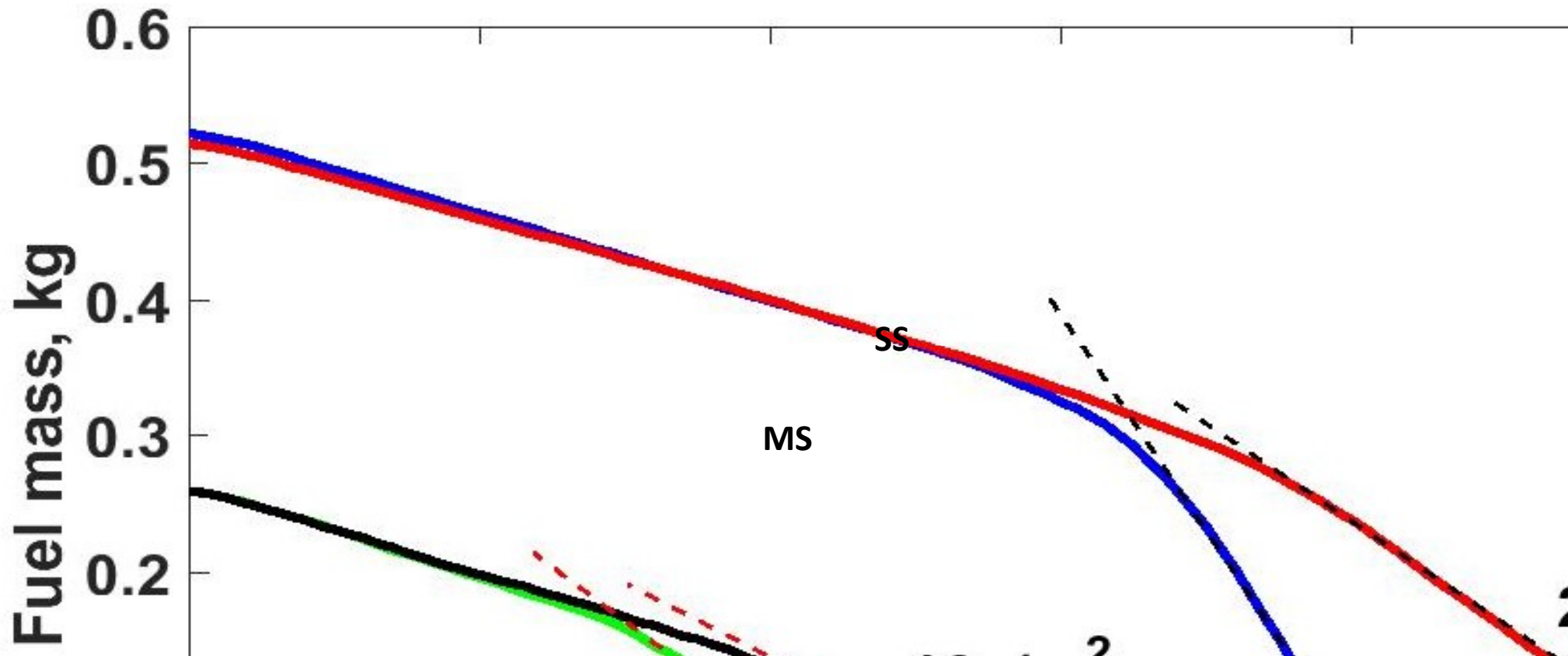

- The burn behavior is similar to n-heptane behavior but with reduced peak flux values
- Mass flux increases with increase in thickness of fuel and MS pan experiment has higher flux compared to SS.

**Fuel depth and material effect on burn rate of diesel in 200 mm dia, 40 mm depth MS and SS pan**

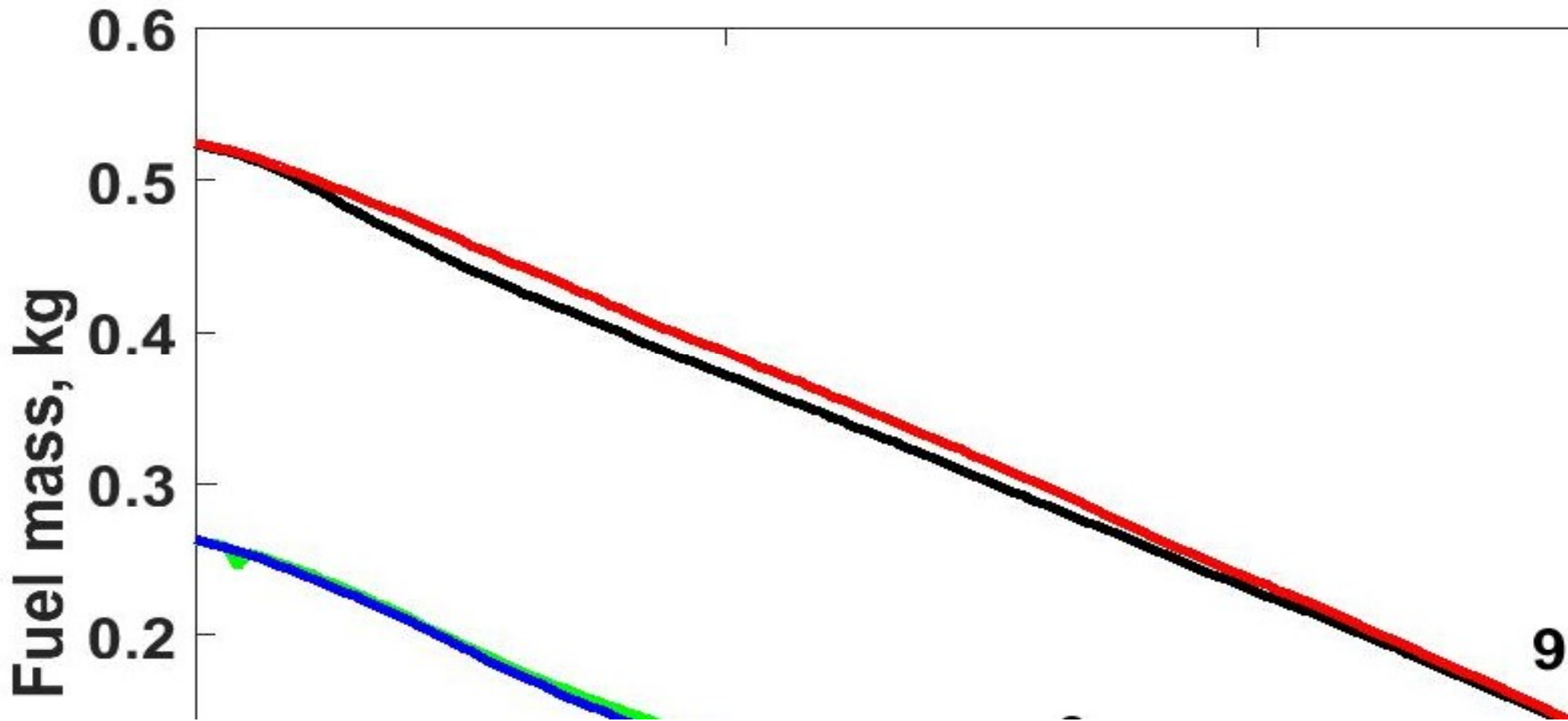

Fuel thickness and material effect on the burn rate is negligible for diesel fuel

## Fuel depth effect on burn rate of methanol and ethanol fuel in 200 mm dia, 40 mm depth MS pan

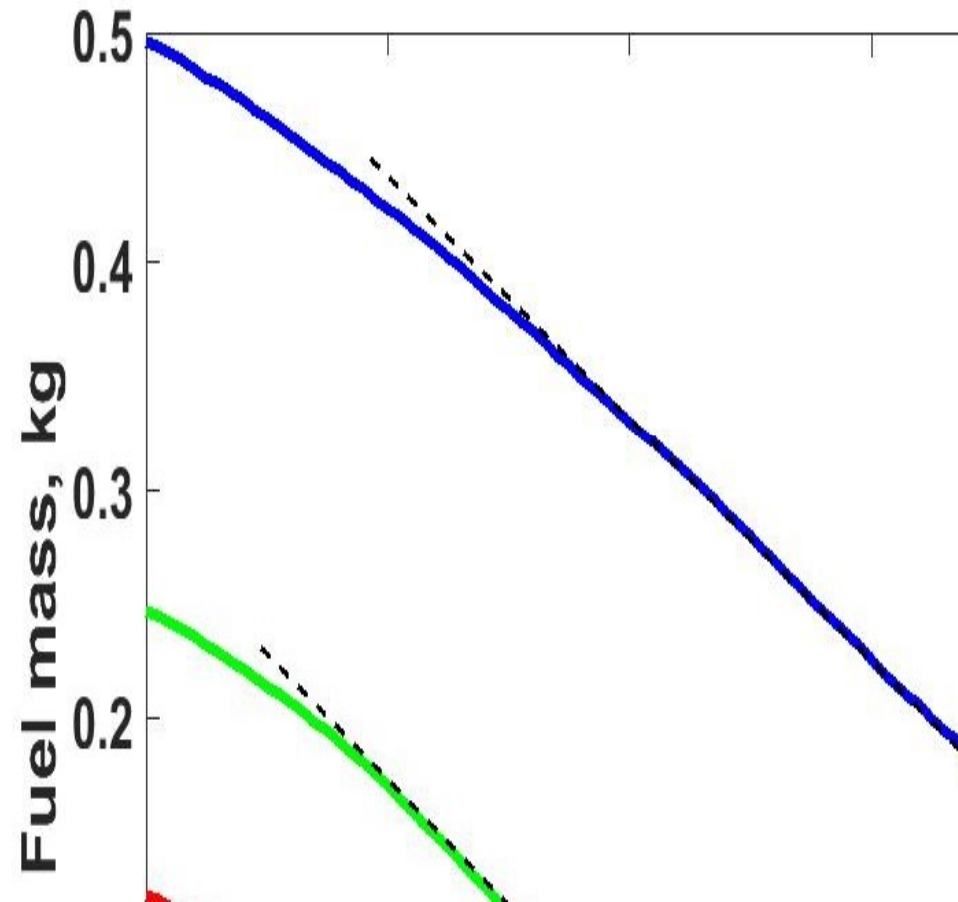
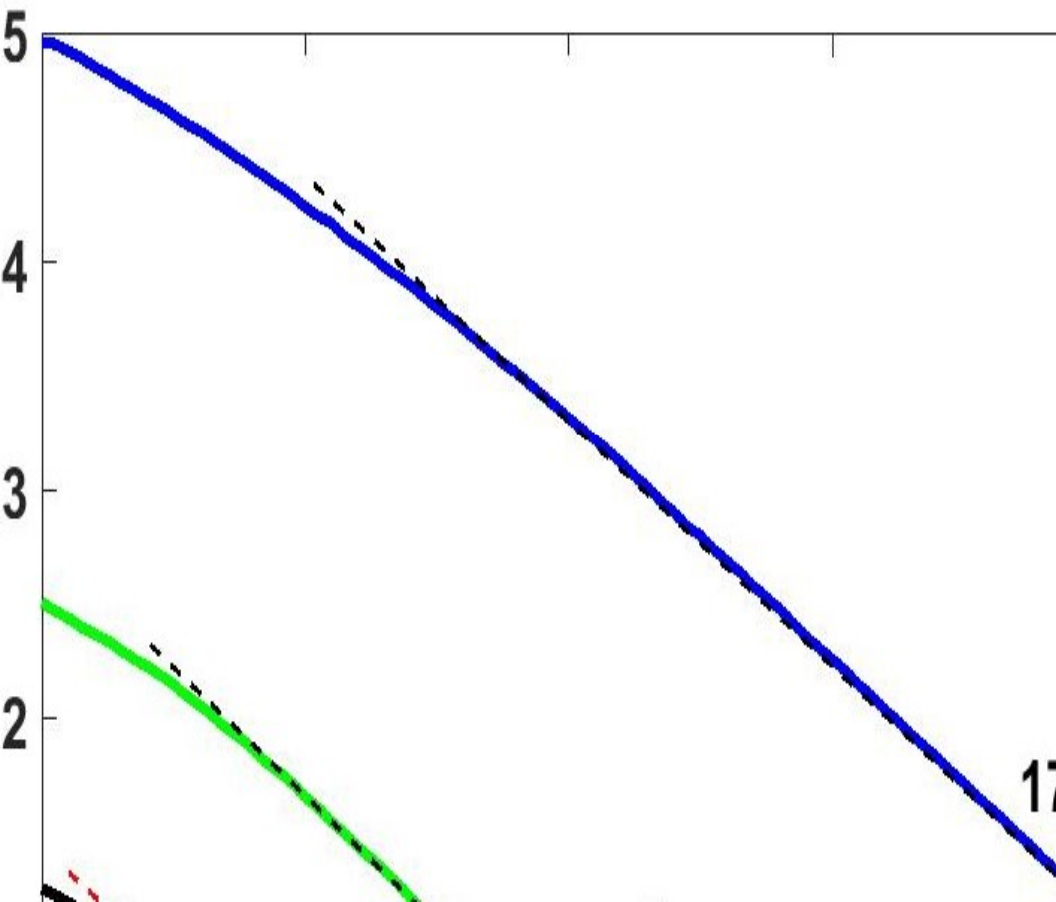

Fuel depth effect on burn rate is negligible for methanol and ethanol



## Fuel temperature of different fuels at 1mm height from the bottom of pan

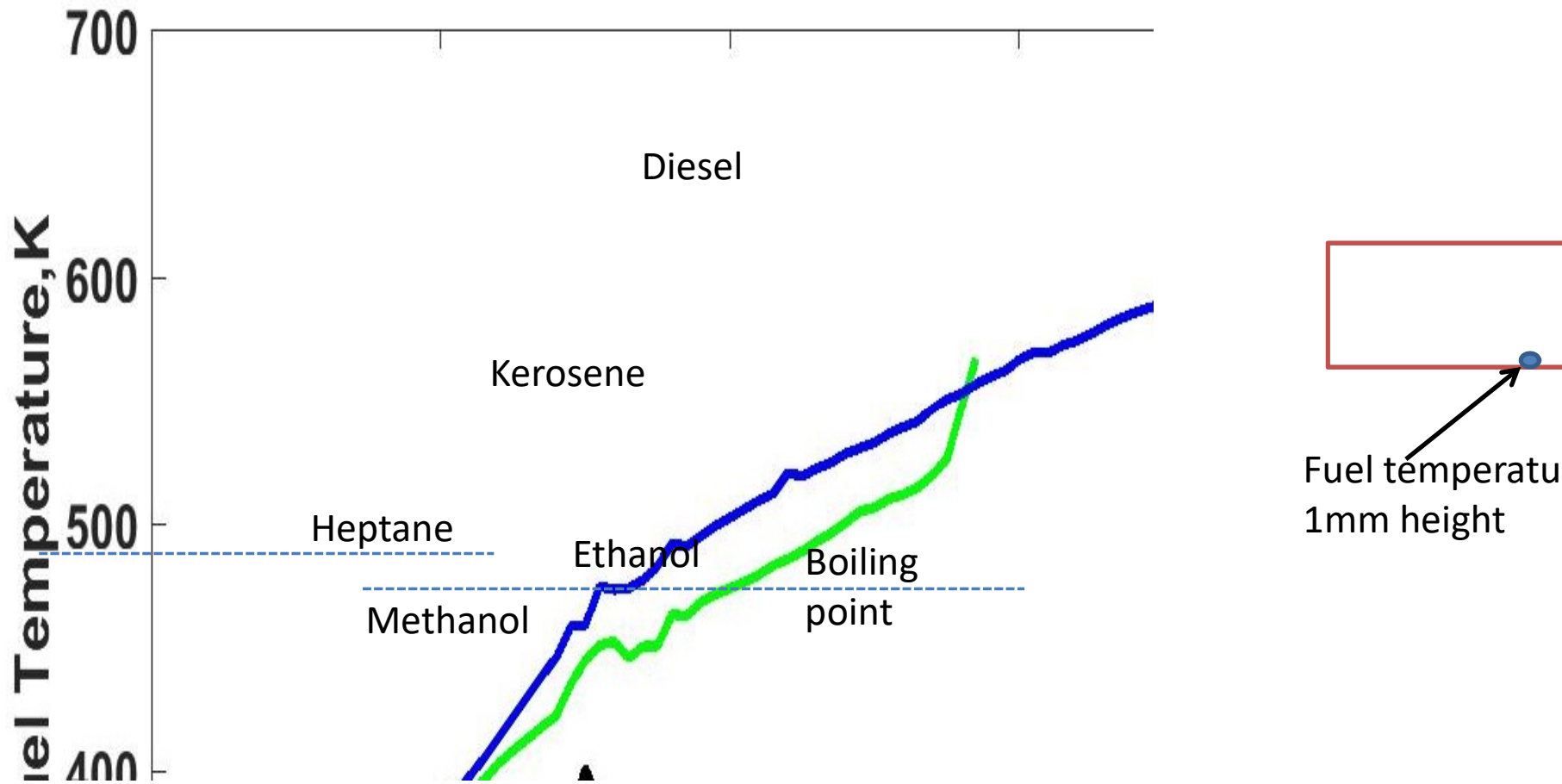

- In case of pure fuels – heptane, methanol and ethanol, the maximum temperature is the boiling point
- In the case of kerosene and diesel, the temperature increases to much larger values

Mass loss rate of different fuels in C200mm dia, 40mm deep MS pan.

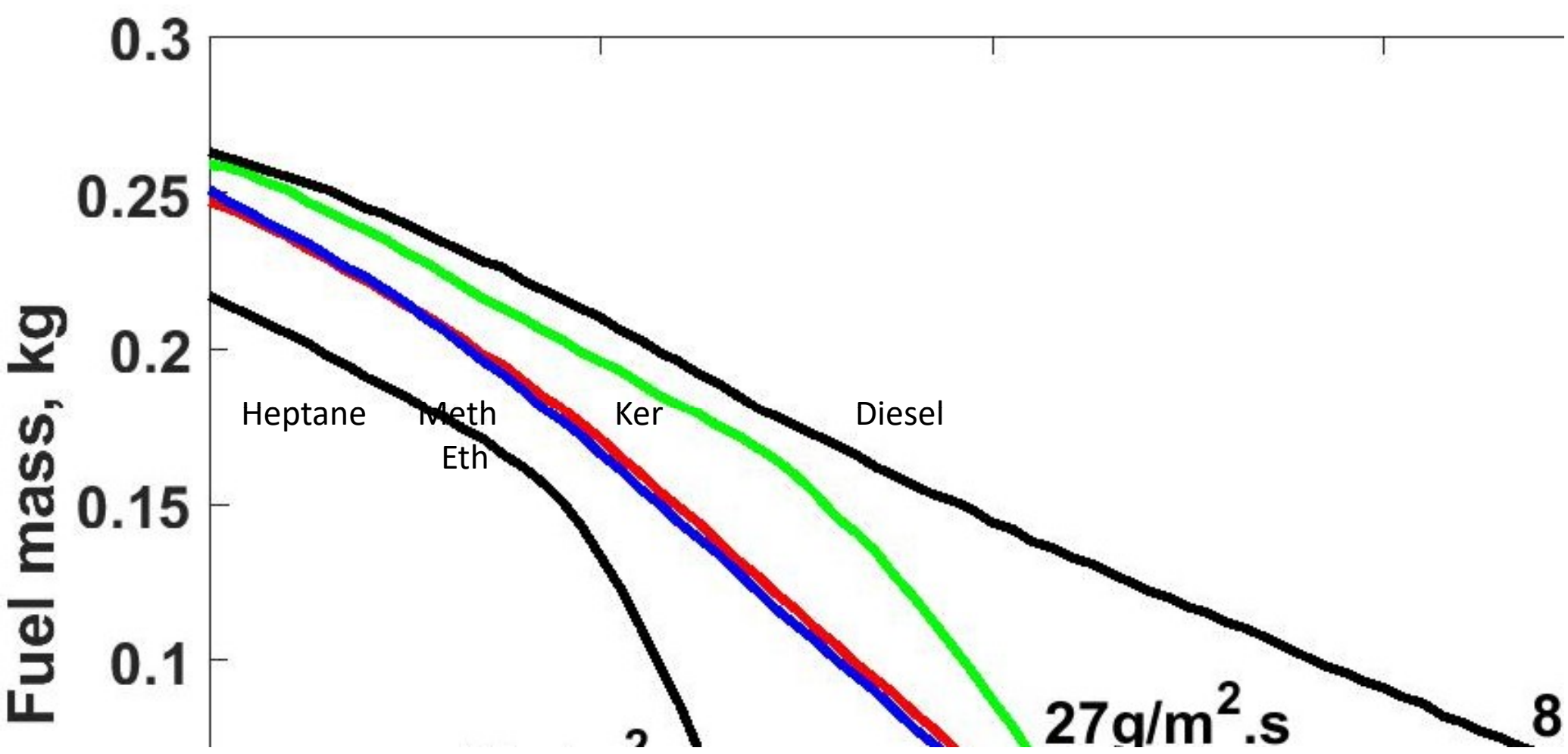

# Key points from the experiments

The experiments conducted here and those in China for n-heptane match well over the range tested  
200 mm dia SS pan with 13 mm fuel thickness.

The present experiments are with AL, MS, SS and GL with a factor 60 in thermal conductivity change  
and 24 in thermal diffusivity change and fuel thickness explored are 10 to 20 mm for n-heptane fuel

in terms increasing order of burn rate fluxes, - diesel, methanol, ethanol, kerosene and heptane

*With glass, the dominant heat transfer mode is convection. With others, there is increasing radiation  
conduction and at larger diameters and higher fuel fluxes, some radiation as well.*

*Sharp changes in burn rate with MS and AL are due to very fast conduction through the  
causing sudden appearance of boiling heat transfer all over.*

## Non-Dimensional Number, $M_{pc}$

evolution of a dimensionless number for defining pan conduction,  $M_{pc}$  to account the burn rate behavior solve the following aspects.

**Increase in wall material thermal conductivity ( $k_w$ ) should increase the heat transfer into the pan and hence increase  $M_{pc}$ .**

**Increase in free board ( $h_{fb}$ ) and pan depth ( $h_{pan}$ ) should reduce the heat transfer and hence  $M_{pc}$ .**

**Increase in fuel thickness ( $h_{fu}$ ) increases the burn rate and hence  $M_{pc}$ .**

**Increase in pan diameter increases the burn rate and must be so reflected in  $M_{pc}$ .**

**Decrease in pan wall thickness should result in reduced conductive flux and should be reflected in  $M_{pc}$ .**

**Increase in initial fuel temperature increases the burn rate and hence  $M_{pc}$ .**

Considering conductive heat transfer coefficient,  $k_w/h_{pan}$  dimensionless is performed using the convective transfer coefficient,  $h_{g;conv}$  that is obtained by expecting that the burn rate flux is controlled by convection in early stages in a small diameter pan.

In regard to other dimensions - fuel thickness, free board, pan diameter and pan wall thickness, dimensionless constructions are possible. Amongst these, one candidate for rendering the fuel thickness dimensionless is conduction thickness,  $k_{fu}/h_{g;conv}$  whose value is about 0.03 m.

# Non-Dimensional Number, $M_{pc}$

candidate for rendering the pan diameter dimensionless should arise from free convective length scale,  $[\nu_g^2/g]^{1/3}$ , where  $\nu_g = \mu_g/\rho_g$  is the dynamic viscosity of the hot gases. With  $\mu_g = 1.8 \times 10^{-5}$  kg/m.s,  $g =$  acceleration due to gravity, this length scale is 21m.

Since these dimensions are independent quantities, they can be incorporated into a constant.

After much study, the dimensionless number is grouped into product of four parameters as shown below

$[k_w t_w h_{fu} / (h_{pan} h_{g,conv})]^{1/3}$  - accounts for conductive and convective heat transfer effects

$\{[1 - \exp(-7 h_{fu}^{0.2} (h_{fb}/h_{pan})^{0.05} * d_{pan}^{1.3} (1 + 0.1 * h_{wr} d_{pan}^{1.3}/h_{pan}^{2.3}))]\}^{0.45}$  - accounts for pan diameter in addition to free board  $h_{fb}$  and fuel depth  $h_{wr}$

$[T_{bfu}/T_0 - 1]^{0.45}$  - accounts for initial fuel temperature

$c_{pg} * T_0 / [L + c_{pfu}(T_{bfu} - T_0)]$  - accounts for fuel properties

$M_{pc} = 285 * P1 * P2 * P3 * P4$ , The constant 285 is chosen such that the value of  $M_{pc}$  corresponds to the flux values for larger diameter

$k_w$  is conductive heat transfer coefficient,  $h_{gcv0}$  is convective heat transfer coefficient,  $h_{fu}$  is fuel depth,  $h_{fb}$  is free board depth in mm,  $L_{fu}$  is latent heat of vaporization of fuel in kJ/kg,  $c_{pfu}$  is specific heat of fuel in kJ/kg K,  $T_{bfu}$  is fuel boiling temperature in K,  $T_0$  is initial temperature of fuel in K

*The various values of indices were obtained to reduce the mean square error after extensive comparison with experimental data*

# The experimental parameters and $M_{pc}$

$$h_{pan} = 0.04 \text{ m}, d_{pan} = 0.2 \text{ m}$$

atf	kw	$\rho_w$	$c_{pw}$	$\alpha_w$	hfu	$T_0$	$L_{fu}$	$T_{bfu}$	$c_{pfu}$	$L_{fu}/c_{pfu}$ ( $T_{bfu}-T_0$ )	Mpc
	W/m K	kg/m <sup>3</sup>	kJ/kg K	mm <sup>2</sup> /s	m	K	kJ/kg	K	kJ/kgK		
AL	60	2710	0.91	24.33	0.02	300	322.0	369	2.10	2.2	49.4
AL	60	2710	0.91	24.33	0.013	300	322.0	369	2.10	2.2	40.1
AL	60	2710	0.91	24.33	0.01	300	322.0	369	2.10	2.2	35.4
MS	32	7850	0.5	8.15	0.02	300	322.0	369	2.10	2.2	40.1
MS	32	7850	0.5	8.15	0.013	300	322.0	369	2.10	2.2	32.8
MS	32	7850	0.5	8.15	0.01	300	322.0	369	2.10	2.2	29
SS	16	7880	0.46	4.41	0.02	300	322.0	369	2.10	2.2	32
SS	16	7880	0.46	4.41	0.013	300	322.0	369	2.10	2.2	26
SS	16	7880	0.46	4.41	0.01	300	322.0	369	2.10	2.2	23
GL	1.14	2320	0.75	0.66	0.02	300	322.0	369	2.10	2.2	13
GL	1.14	2320	0.75	0.66	0.013	300	322.0	369	2.10	2.2	10.8
GL	1.14	2320	0.75	0.66	0.01	300	322.0	369	2.10	2.2	9.4

Conducti  
transfer v

Conducti  
transfer l

Conducti  
transfer n  
with con

Convecti  
transfer n  
dominan

$L_{fu}$  = Heat of vaporization of n-Heptane,  $T_{bfu}$  = Boiling point of n-Heptane



# Correlation to predict the mean burn rate

$$\begin{aligned} \dot{m}_{fu} \text{ (g/m}^2\text{-s)} &= 7.8 + 0.74M_{pc} \text{ for } M_{pc} < 26.5 \\ &= 213 - 7 * M_{pc} \text{ for } 26.5 < M_{pc} < 27.5 \\ &= 0.79 * M_{pc} - 1.2 \text{ for } M_{pc} > 27.5 \end{aligned}$$

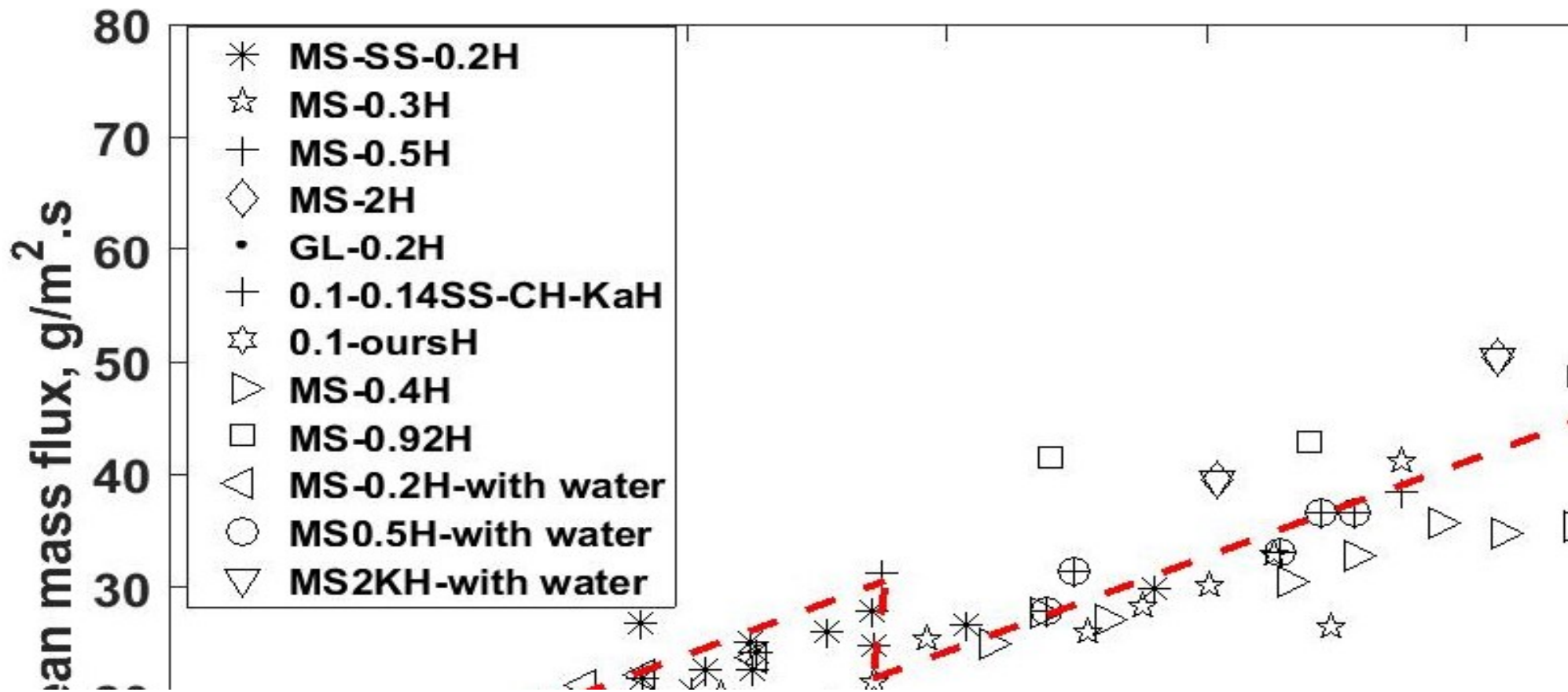

# Conclusions - 1

burn rate is strongly dependent on the fuel thickness, pan material and initial temperature of the fuel. This is observed in the case of n-heptane and kerosene fuel.

The principal mechanisms governing the burn rate are identified clearly:

**All pan materials have initial burn controlled by convective flux.**

**The initial convective flux for all the pans is described by convective heat transfer coefficient of  $4.5 \text{ W/m}^2\text{K}$  (this value is obtained from a MATLAB simulation of the burn rate process not discussed here)**

**Smaller pans have increased contribution of conductive flux depending on the thermal conductivity of wall material.**

**Larger pans will in addition get enhanced contribution of radiation.**

The increase in burn flux which is generally observed in larger diameter pans can be obtained in the smaller pans by increasing the thickness of fuel, this increase is being due to conductive heat transfer.

The intriguing behaviour of sharp burn rate change caused by high conductivity wall material (Al) as different from SS is brought out in case of n-heptane and kerosene fuels. The interplay of wall thermal conductivity and heat drawn away through the wall is considered the reason.

# Conclusions - 2

n-dimensional parameter ( $M_{pc}$ ) to distinguish the burn behaviour of materials of pans, fuel depth and initial temperature is set out. It is also used to obtain a correlation for the burn rate flux of fuels discussed here.

The results are consistent with general understanding, but this work provides quantitative estimates for the burn rate given the geometric parameters of the pan and thermochemical parameters of the fuel. It is expected that the correlations would be realistic for other fuels (mixture of the primary fuels, for instance).

.....Thank you.